

AccuForce 12V - 33Ah | VRLA Battery



Specifications

Nominal Voltage	12 V		
Number of cells	6		
Design Life	10 years		
Dimensions	Length	195 mm	
	Width	130 mm	
	Height	155 mm	
	Total Height	166 mm	
Approx. Weight	9.2 kg		
	20 hours rate (1.73 A, 10.8 V)	34.6 Ah	
Nominal Capacity (25°C)	10 hours rate (3.30 A, 10.8 V)	33.0 Ah	
	5 hours rate (5.78 A, 10.5 V)	28.9 Ah	
	1 hour rate (20.50 A, 9.6 V)	20.5 Ah	
	Max. Discharge Current (25°C)	330 A (5s)	
Internal Resistance	10 mOhms		
Fully Charged battery (25°C)	3%		
Self-Discharge	3% of capacity declined per month at 20°C (average)		
	Discharge	-15°C~50°C	
	Charge	-10°C~50°C	
	Storage	-20°C~50°C	
Operating Temperature Range	880 A		
	Short Circuit Current	880 A	
Charging Characteristics (25°C)	Boost charging voltage	2.40-2.45 Vpc	
	Maximum charging current	9.9 A	
	Temperature compensation	-30 mV/°C	
	Float charging voltage	2.23-2.27 Vpc	
	Temperature compensation	-18 mV/°C	

Applications

- Uninterruptible Power Supplies (UPS)
- Electric Power Systems (EPS)
- Emergency backup power supplies
- Electronic apparatus and equipment
- Communication power supplies
- DC power supplies
- Auto control system

Battery Construction

Component	Positive Plate	Negative Plate	Container	Cover	Safety Valve	Terminal	Separator	Electrolyte
Raw material	Lead dioxide	Lead	ABS	ABS	Rubber	Pb	Fiberglass	Sulfuric acid

Dimensions

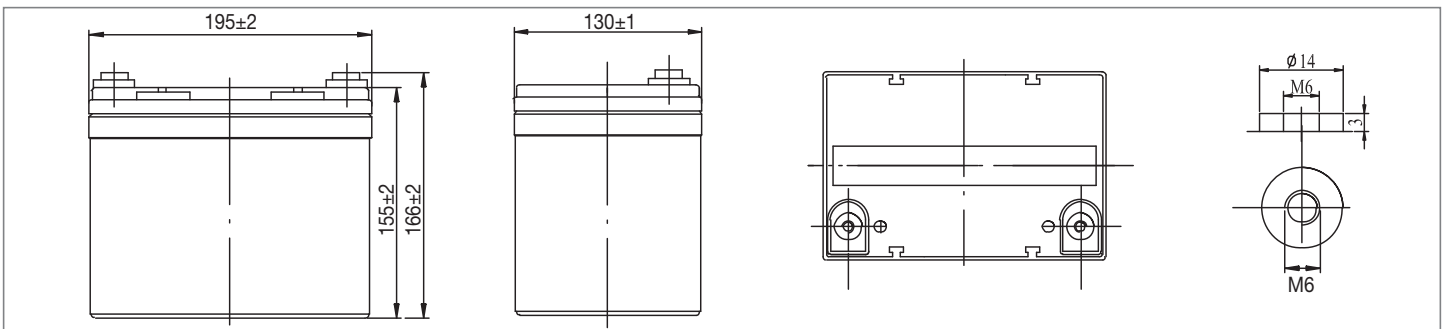

Constant Current Discharge (Amperes) at 25°C

End Voltage (Volts/Cell)	10min	15min	30min	1h	2h	3h	4h	5h	8h	10h	20h
1.60 V	69.3	54.5	33.0	20.5	12.1	8.42	6.90	5.89	4.04	3.36	1.76
1.65 V	67.2	53.1	32.3	20.2	12.0	8.37	6.86	5.86	4.02	3.35	1.76
1.70 V	64.4	51.2	31.4	19.6	11.9	8.31	6.81	5.82	3.99	3.34	1.76
1.75 V	61.7	49.4	30.6	19.3	11.7	8.25	6.77	5.78	3.96	3.32	1.74
1.80 V	58.2	46.8	29.5	18.7	11.4	8.00	6.56	5.60	3.84	3.30	1.73

Constant Power Discharge (Watts) at 25°C

End Voltage (Volts/Cell)	10min	15min	30min	1h	2h	3h	4h	5h	8h	10h	20h
1.60 V	748	598	370	233	140	99.0	81.1	69.6	48.0	40.1	21.2
1.65 V	726	584	363	230	139	98.4	80.7	69.2	47.7	40.0	21.1
1.70 V	696	562	352	224	138	97.7	80.1	68.7	47.4	39.9	21.1
1.75 V	666	543	343	219	136	97.0	79.6	68.3	47.0	39.7	20.9
1.80 V	629	514	331	213	132	94.1	77.2	66.2	45.6	39.4	20.8

(Note) The above characteristics data are average values obtained within three charge/discharge cycles not the minimum values.

AccuForce 12V - 33Ah | VRLA Battery

Temperature Effects on Float Life

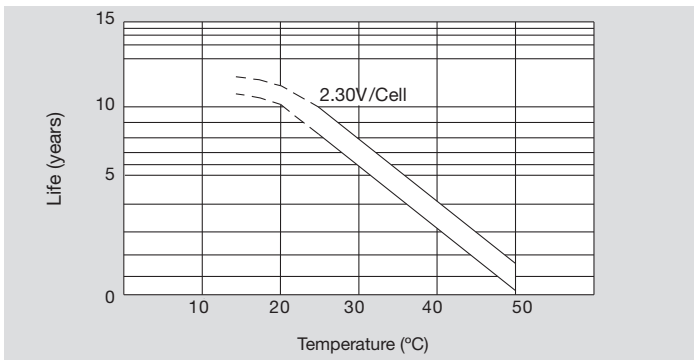

Self Discharge Characteristics

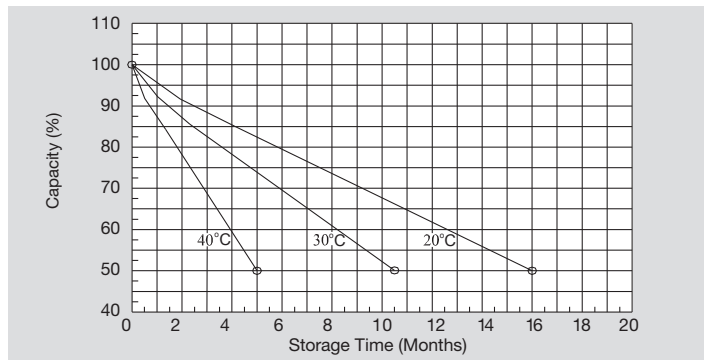

Discharge Characteristics (25°C)

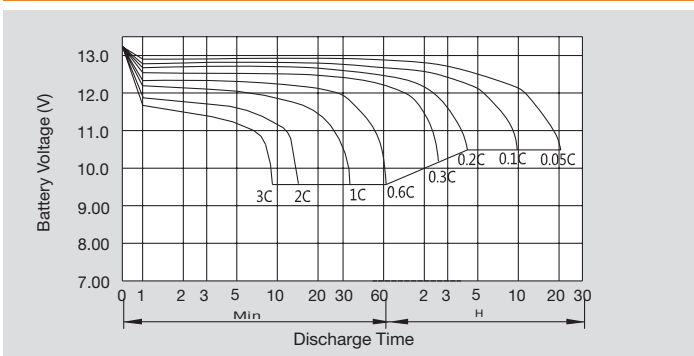

Charging Characteristics (25°C)

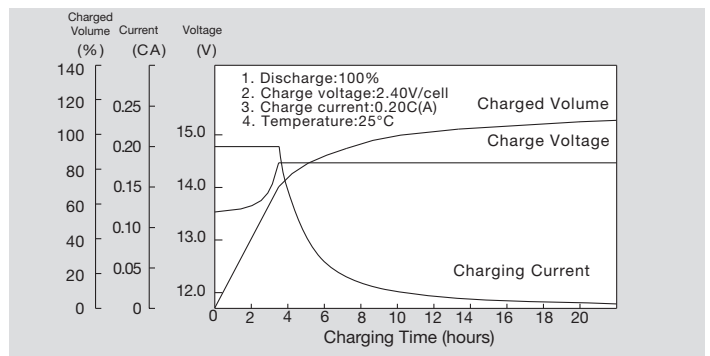

Relationship Between Charging Voltage and Temperature

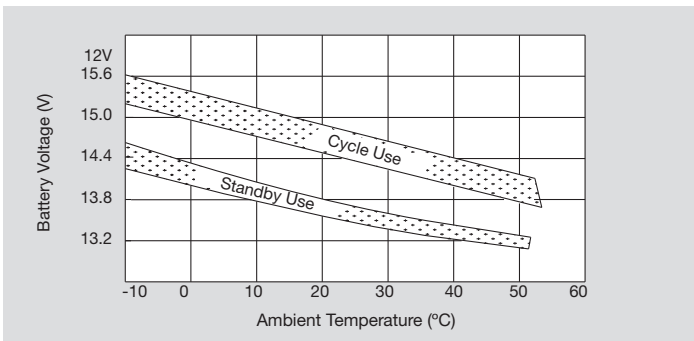

Relationship Between OCV and Residual Capacity (25°C)

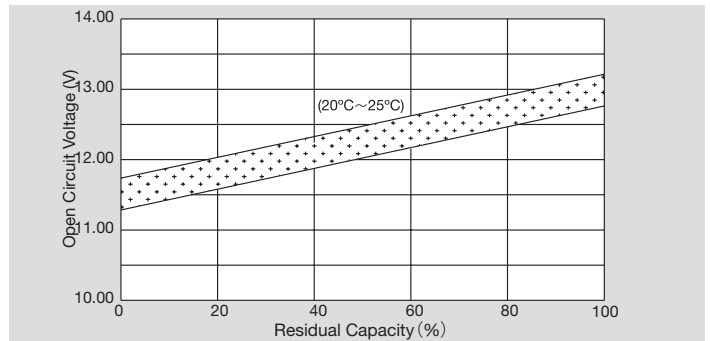

Cycle Service Life in Relation to Depth of Discharge

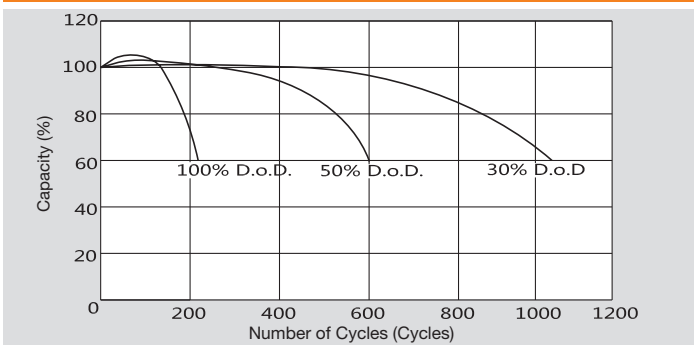

Temperature Effects on Capacity

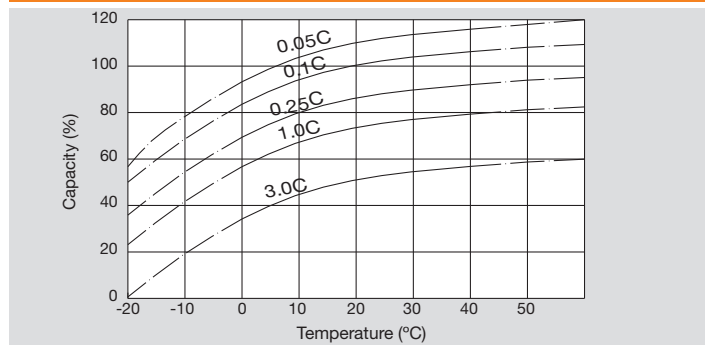

SYSTEMS SUNLIGHT S.A.

Headquarters

2 Ermou & Nikis Str., Syntagma Sq.
105 63 Athens, Attica, Greece

T +30 210 6245400 F +30 210 6245409 Global Service Department

European Manufacturing Plant 366 Tatoiou Str.
672 00 Neo Olvio, Xanthi, Greece 136 73 Acharnes, Attica, Greece

T +30 25410 48100 F +30 25410 95446 T +30 210 6245600 F +30 210 6245619

